



HRM  
继电器



519947



241303-1



P06206193



313776-01



No.50062740



140007



1063016



E164730



CQC02001001670



### 1.线圈参数

1-1.额定电压	3,5,6,9,12,24,48VDC
1-2.线圈电阻	见规格表
1-3.吸合电压	见规格表
1-4.释放电压	见规格表
1-5.额定线圈功率	540mW、720mW

### 2.触点参数

2-1.触点形式	A—组常开,C—组转换
2-2.触点材料	Ag Alloy
2-3.触点负载	阻性:10A 250VAC/30VDC,TV-5 感性:5A 240VAC(COSΦ=0.4)
2-4.最大切换电压	250VAC/30VDC
2-5.最大切换电流	10A
2-6.最大切换功率	2,500VA,300W
2-7.最小切换电压电流	5VDC,100mA
2-8.接触电阻(首次)	Max 100mΩ(6VDC 1A)
2-9.寿命	
电气寿命	100,000次
机械寿命	50,000次(COSΦ=0.4,L/R=7ms) 10,000,000次

### 3.通用参数

3-1.绝缘电阻	Min.1000MΩ 500VDC
3-2.介质耐压	1,000VAC,1 min触点与触点间 4,000VAC,1 min触点与线圈间
3-3.吸合时间	Max.15ms
3-4.释放时间	Max.8ms
3-5.温度范围	-30 ~ +55℃(720mW) -30 ~ +70℃(540mW)
3-6.冲击	
强度	1,000m/s <sup>2</sup>
稳定性	100m/s <sup>2</sup>
3-7.振动	
强度	10 ~ 55Hz,1.5mm双振幅
稳定性	10 ~ 55Hz,1.5mm双振幅
3-8.相对湿度	35% ~ 95%RH,+40℃
3-9.重量	约13g
3-10.安规	UL NO.E164730 TUV NO.50062740 VDE NO.140007 CSA NO.1063016(LR 109368) CQC NO.02001001670 SEMKO NO.519947



HRM  
继电器



519947



241303-1



P06206193



313776-01



No.50062740



140007



1063016



E164730



CQC02001001670



#### 4. 订货代码

HRM H - S - DC5V - A

触点形式

A- 一组常开

C- 一组转换

线圈电压

DC3V, DC5V, DC6V, DC9V, DC12V, DC24V, DC48V

密封性

S - 塑封型

线圈功率

H-高灵敏型540mW

无-标准型720mW

继电器型号

#### 5. 规格表

20°C

型号规格	线圈额定电压 VDC	线圈电阻 $\Omega \pm 10\%$	吸合电压 $\leq VDC$	释放电压 $\geq VDC$	额定线圈功率 mW
HRM-(S)-DC3V	3	12.5	2.25	0.3	720
HRM-(S)-DC5V	5	35	3.75	0.5	
HRM-(S)-DC6V	6	50	4.50	0.6	
HRM-(S)-DC9V	9	112.5	6.75	0.9	
HRM-(S)-DC12V	12	200	9.0	1.2	
HRM-(S)-DC24V	24	800	18.0	2.4	
HRM-(S)-DC48V	48	3200	36.0	4.8	
HRMH-(S)-DC3V	3	17	2.25	0.3	540
HRMH-(S)-DC5V	5	46	3.75	0.5	
HRMH-(S)-DC6V	6	67	4.50	0.6	
HRMH-(S)-DC9V	9	150	6.75	0.9	
HRMH-(S)-DC12V	12	267	9.0	1.2	
HRMH-(S)-DC24V	24	1067	18.0	2.4	
HRMH-(S)-DC48V	48	4267	36.0	4.8	

#### 6. 外形图、接线图、安装孔尺寸(mm)

外形图

接线图

安装孔尺寸图

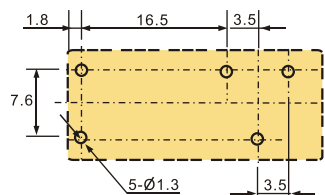
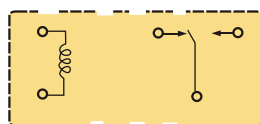
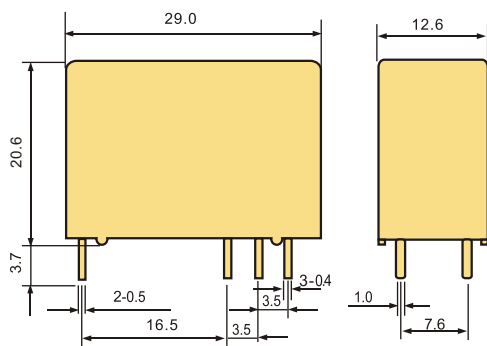

7.HRM特性曲线图

时间曲线(标准型)

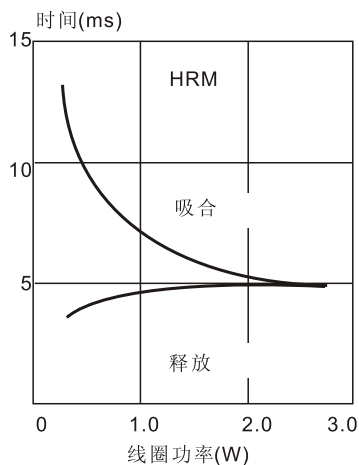

时间曲线(高灵敏型)

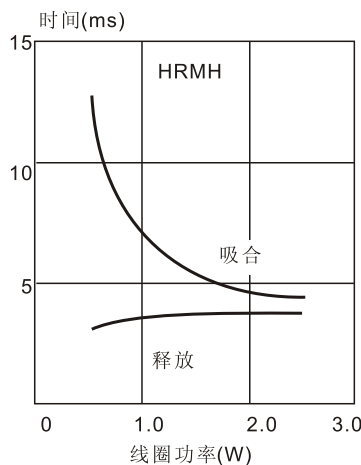

线圈温升(标准型)

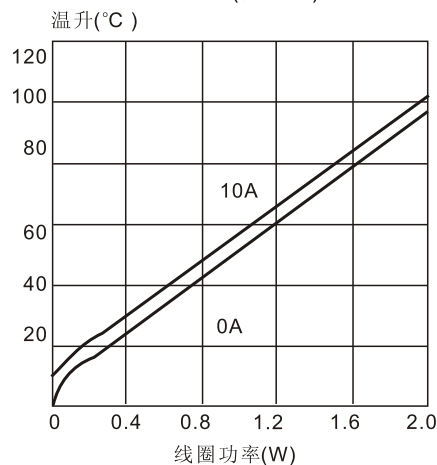

线圈工作范围曲线

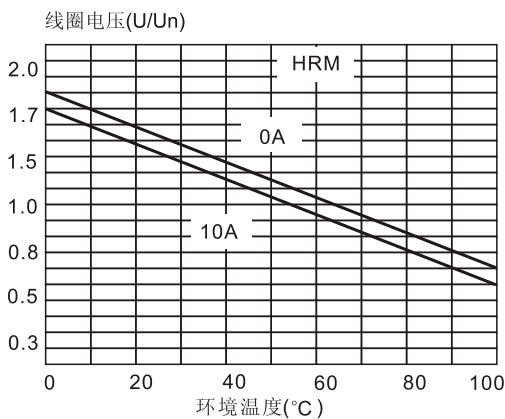

线圈工作范围曲线

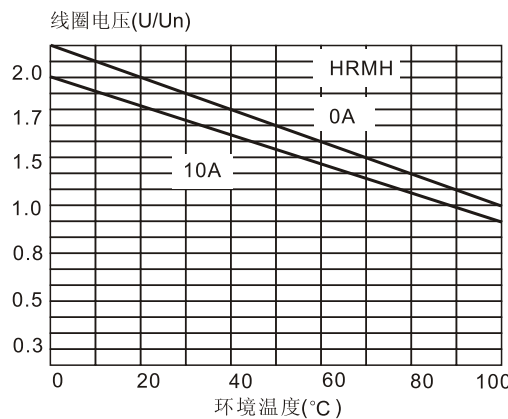

最大切换功率

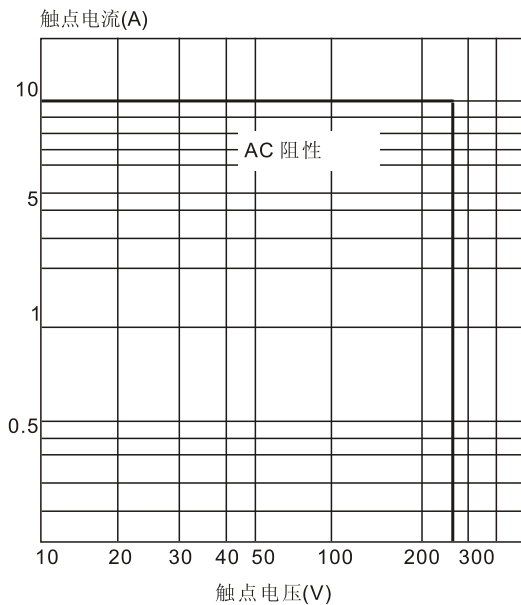

寿命曲线

